



## FW6000-B12120

RECHARGEABLE BATTERY

HX12-12

(12V12Ah)

### SPECIFICATIONS

18 MONTHS WARRANTY

Nominal Voltage		12 V
Capacity (25°C)	20HR(10.5V)	12Ah
	10HR(10.5V)	11.2Ah
	1HR(9.60V)	7.8Ah
Dimension	Length	151 ± 1.5mm (5.94inch)
	Width	98 ± 1mm (3.86inch)
	Height	95 ± 1mm (3.74inch)
	Total Height	101 ± 1mm (3.98inch)
Approx. Weight		3.45kg (7.61lbs) ± 5%
Terminal type		F2/F1
Internal resistance (Fully charged, 25°C)		Approx. 20m Ω
Capacity affected by temperature (20HR)	40°C	102%
	25°C	100%
	0°C	85%
	-15°C	65%
Self-discharge (25°C)	3 month	Remaining Capacity: 91%
	6 month	Remaining Capacity: 82%
	12 month	Remaining Capacity: 65%
Nominal operating temperature		25°C ± 3°C (77°F ± 5°F)
Operating temperature range	Discharge	-15°C ~ 50°C (5°F ~ 122°F)
	Charge	-10°C ~ 50°C (14°F ~ 122°F)
	Storage	-20°C ~ 50°C (-4°F ~ 122°F)
Float charging voltage(25°C)	13.60 to 13.80V Temperature compensation: -18mV/°C	
Cyclic charging voltage(25°C)	14.50 to 15.00V Temperature compensation: -30mV/°C	
Maximum charging current	3.6A	
Maximum discharge current	180A(5 sec.)	
Designed floating life(20°C)	5 years	

### Dimensions

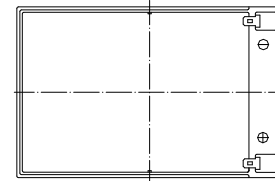
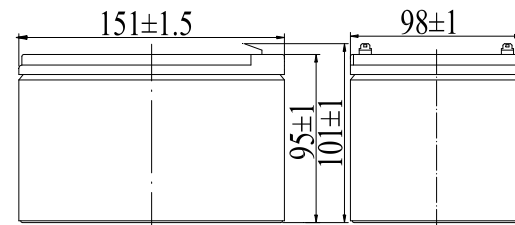

### Terminal

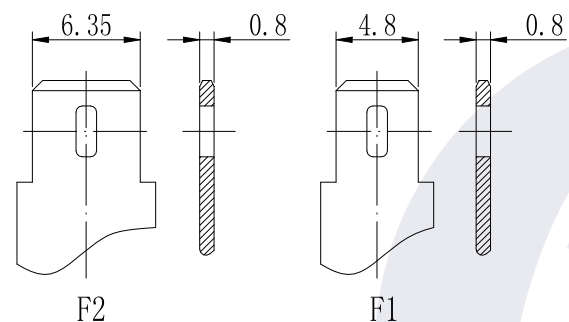

**Constant Current Discharge Characteristics (A, 25°C)**

F.V/TIME	5min	10min	15min	30min	60min	2h	3h	4h	5h	10h	20h
9.60V	45.8	29.0	22.7	12.8	7.86	4.30	2.97	2.46	2.09	1.14	0.61
9.90V	44.5	28.2	22.1	12.5	7.74	4.27	2.96	2.45	2.08	1.13	0.61
10.2V	42.6	27.0	21.3	12.1	7.55	4.24	2.94	2.43	2.07	1.13	0.60
10.5V	40.8	25.8	20.6	11.8	7.40	4.17	2.92	2.41	2.05	1.12	0.60
10.8V	38.5	24.4	19.5	11.4	7.17	4.07	2.83	2.34	1.99	1.10	0.59

**Constant Power Discharge Characteristics (Watt, 25°C)**

F.V/TIME	5min	10min	15min	30min	60min	2h	3h	4h	5h	10h	20h
9.60V	512	328	259	146	91.0	50.3	35.3	29.3	25.0	13.6	7.31
9.90V	496	318	252	144	89.7	50.0	35.1	29.1	24.8	13.6	7.28
10.2V	476	305	243	139	87.4	49.6	34.9	28.9	24.7	13.5	7.24
10.5V	455	292	235	136	85.6	48.8	34.6	28.7	24.5	13.4	7.20
10.8V	430	275	222	131	83.0	47.6	33.6	27.9	23.8	13.2	7.06

Note: The above characteristics data can be obtained within three charge/discharge cycles.

**Construction**

Component	Positive plate	Negative plate	Container	Cover	Separator	Electrolyte	Safety valve	Terminal
Raw material	Lead dioxide	Lead	ABS	ABS	AGM	Sulfuric acid	Rubber	Copper

**Discharge Characteristics(25°C)**

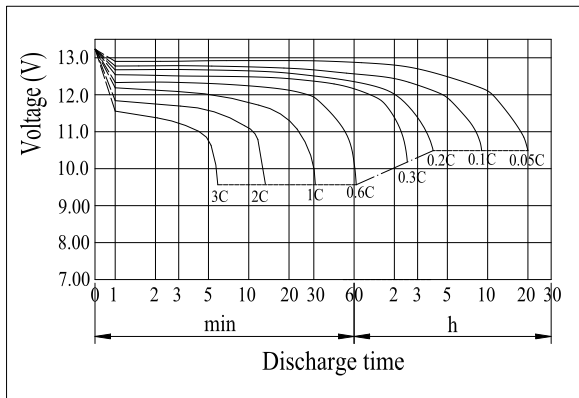

**Charging Characteristics(25°C)**

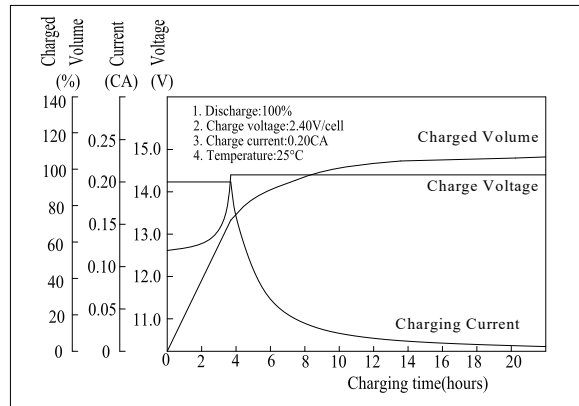

**The Relationship for Open Circuit Voltage and Residual Capacity (25°C)**

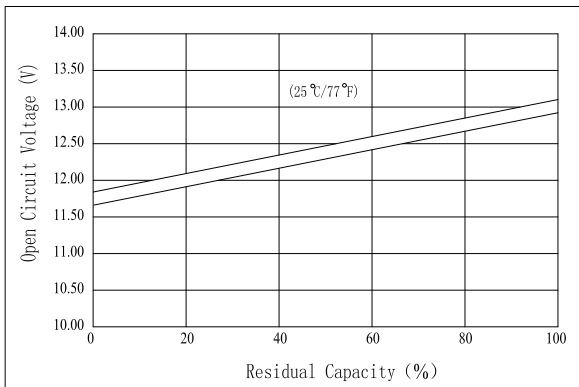

**The Relationship for Charging Voltage and Temperature**

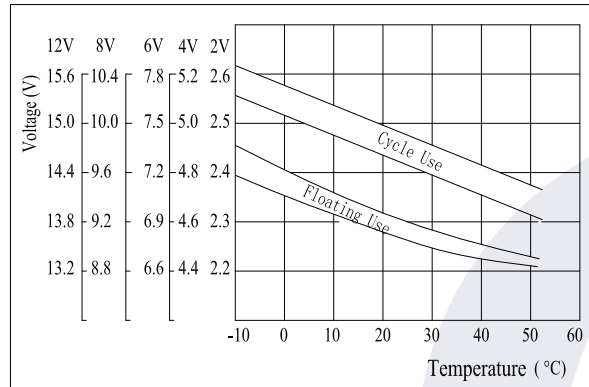

**Floating Life on Temperature**

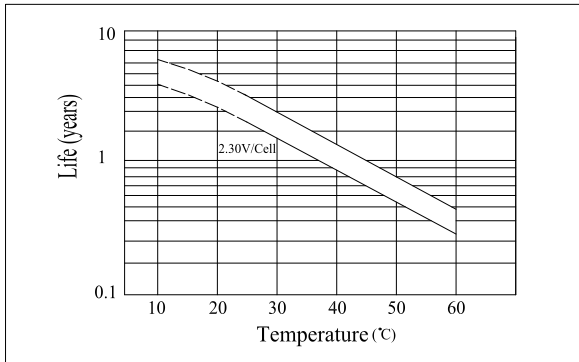

**Cycle Life on D.O.D(25°C)**

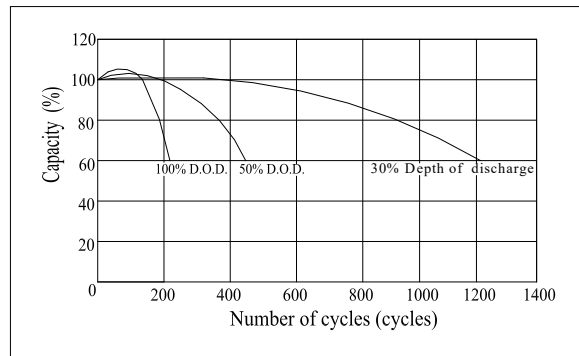

**Effect of Temperature on Capacity**

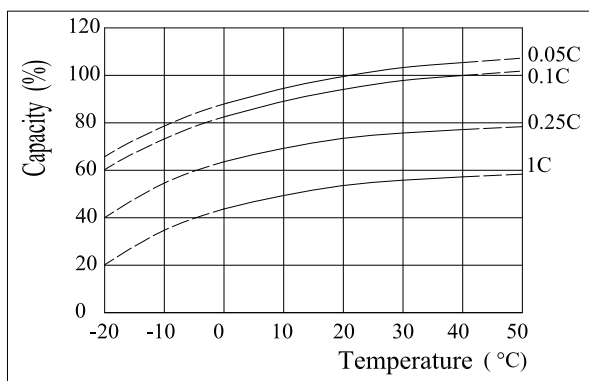

**Self-discharge Characteristics**

